

# Lithium Manganese Dioxide Battery

# CR2032

### ■ Dimensions(mm)

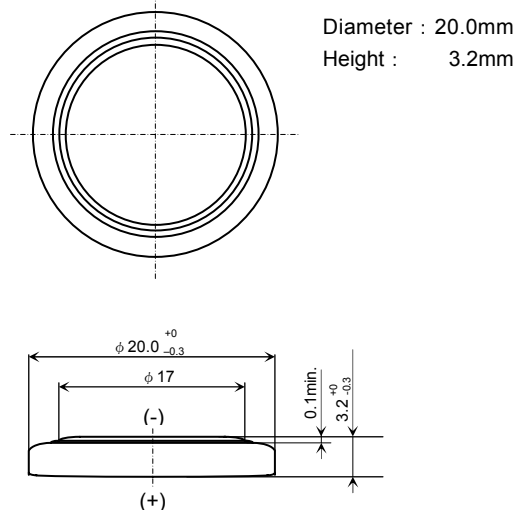

### ■ Specifications

Nominal Voltage	3V
Nominal Capacity ( 2.0V cutoff)	220mAh
Standard Discharge Current	0.2mA
Weight	3.2g

#### Applications

- Electronic Watch or Clock
- Electronic Calculator
- Memory Back-up Power Source for SRAM or Real Time Clock (RTC)

### ■ Discharge Characteristics

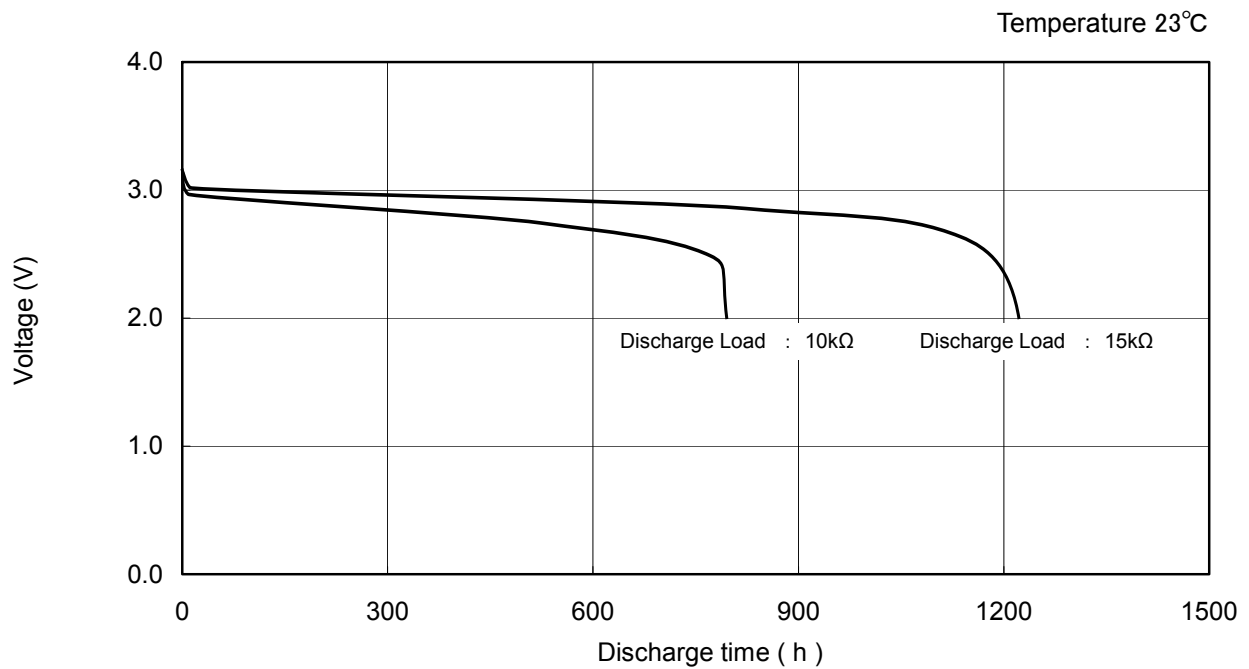

■ Discharge Characteristics on Load

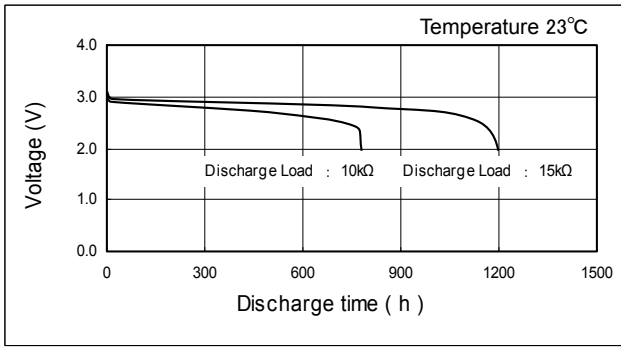

■ Discharge Characteristics on Temperature

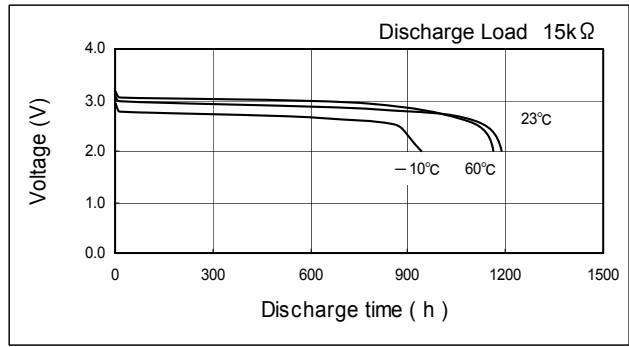

■ Discharge Load vs. Operation Voltage (Discharge depth 40%)

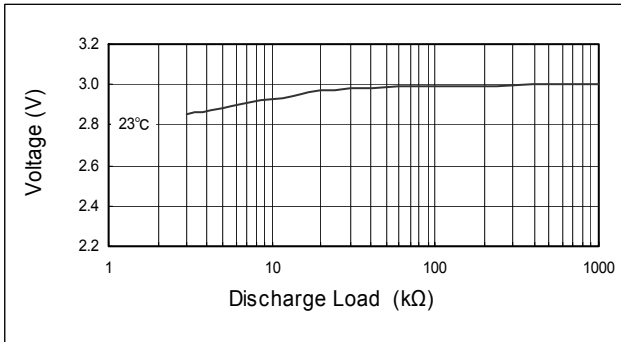

■ Discharge Load vs. Discharge Capacity

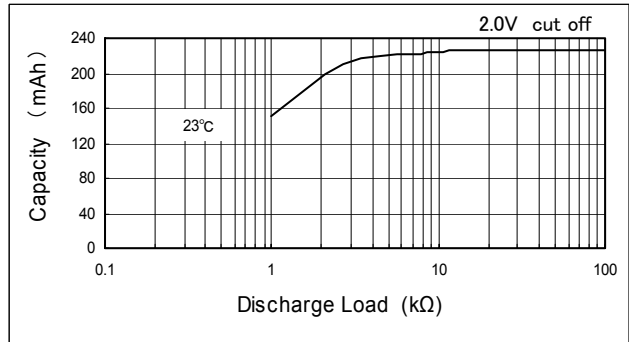

■ Discharge Characteristics on Pulse Load (Discharge depth 40%)

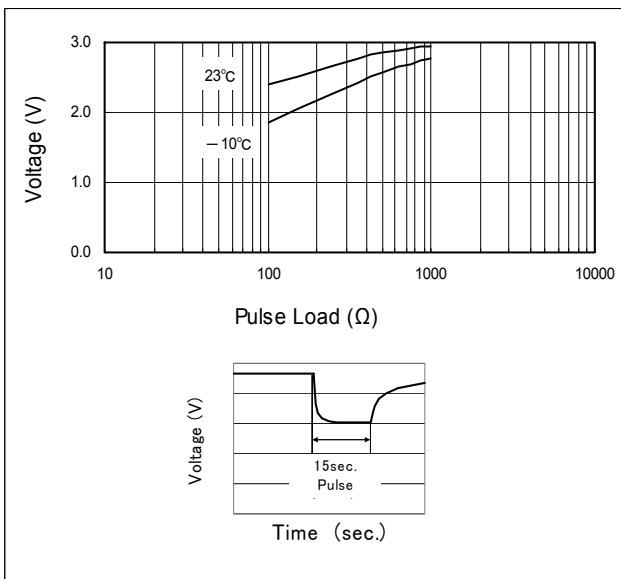

■ Storage Characteristics

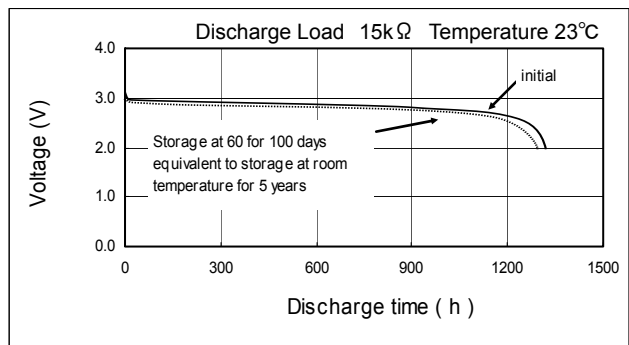

\* These values are not guarantee.